

Laura Ashley

Provencale Bookcase

Thank you for purchasing this product. Please read the instructions carefully before use to ensure safe and satisfactory operation of this product.

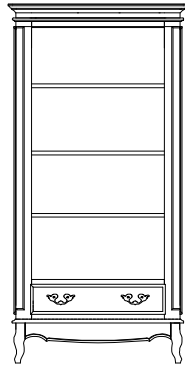

Please ensure instructions are read in full





before commencing with this product.

Necessary Tools

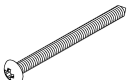
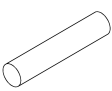

Please check the pack contents before you begin. A full checklist of components is given in this leaflet. If any components are missing, please contact the retailer from whom you bought this product.

Hardware And Wall Fixing Pack

A	Screws $\text{Ø}8 \times 2''$ x 8		B	Shelf Supports x 8	
C	Washer x 1		D	Strap x 1	
E	Screw $\text{Ø}8 \times \frac{3}{4}''$ x 1				

Parts

checklist

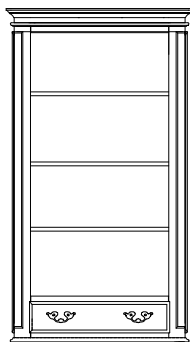

1. Bookcase unit x 1



2. Plinth x 1

Wall fixing - if in doubt seek professional advice

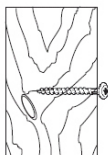

Wood

If fixing to wood make sure that it isn't chipboard as screws can easily pull away from the core structure

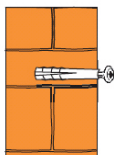

Brick or Masonry

Use an appropriate wall plug provided you are sure your wall is sound

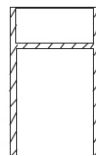

Cavity wall

Special toggle wall plugs are needed. Seek expert advice

To avoid any risk of tipping, this unit must be safely secured to the wall (See Wall Mounting Instructions)

Safety Advice and Assembly Recommendations

- Do not stand or lean on this product.
- Make sure the area is clear when unpacking and positioning this product.
- This product is **heavy**, it should be assembled as near as possible to the point of use. **Take care when lifting** to avoid personal injury and or damage to the product.
- Keep small children/pets away from assembly area. This product has small component parts that are a choking hazard.
- Make sure you assemble this product correctly as per the instructions and ensure all fittings are tight.
- **A minimum two persons is required to lift the Bookcase into position.**
- **We recommend that the packaging is used to protect the surfaces during assembly.**

It must under no circumstances be used free-standing. No liability will be accepted for damage or personal injury caused by inadequate fixing or use without fixing.

Wall Mounting Instructions

1. Attach the **Wall Strap (D)** To the pre drilled hole on the top back of the Bookcase using **Screw (E)** and **Washer (C)** (See illustration). **Fig 2**
2. Determine the final destination of your furniture piece. Ensure the furniture is level and square. Mark location on wall. **Before drilling, check for any hidden water pipes, or electrical wires.**
3. Attach the **Wall Attachment Strap** to the wall with suitable fixings (**not supplied**)
4. Ensure that the wall **bracket/strap** is secure.

If for

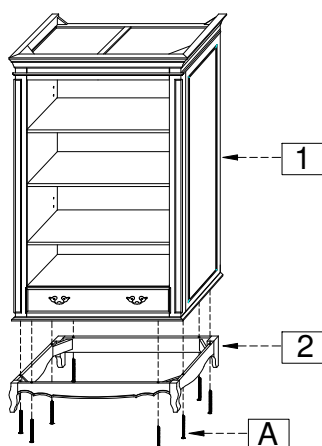

any reason you need to move your furniture, simply remove the wall fixing screw.

Fig 1

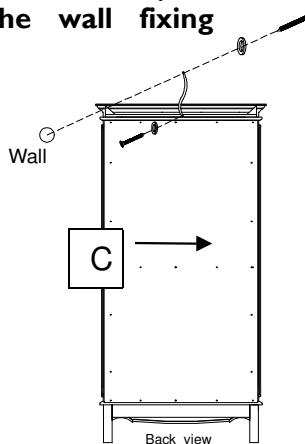

furniture, simply remove the wall fixing screw.

Fig 2

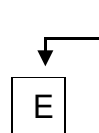
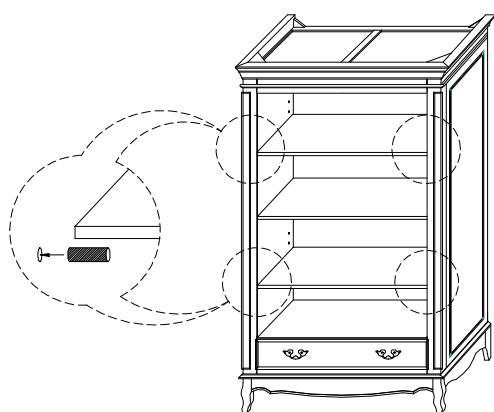

Fig 1

Lay the unit on its back. **We recommend that the packaging is used to protect the surfaces during this process.**

Place the plinth onto the bottom of the unit (Align the pre drilled holes on the plinth with the pilot holes on the base panel) Secure the plinth using **8 Screws (A)**.

To avoid any risk of tipping, this unit **must** be secured to the wall (**See Wall Mounting Instructions**)



Shelf Fitment of Shelves Step I

Insert the **Shelf Supports (8)** in the desired hole position (**See illustration**) **Fig 3** and place the shelves on top of the supports.

To re-position the shelves, repeat **Step I** above.

Fig 3

Care and Maintenance. Please refer to Laura Ashley Care Guide

PLEASE KEEP THESE INSTRUCTIONS FOR FUTURE REFERENCE

**If you have any queries with this product please contact
Laura Ashley Customer Services. Tel: 08719835999**

www.lauraashley.com