

ASSEMBLY INSTRUCTION

HENSHAW DISPLAY CABINET

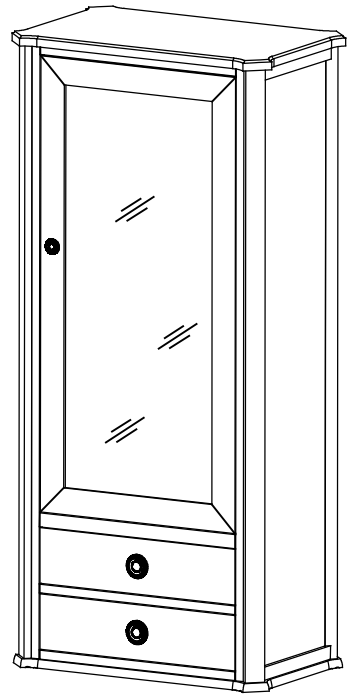

1.

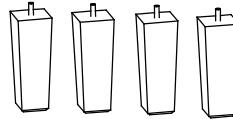
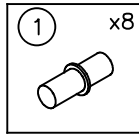
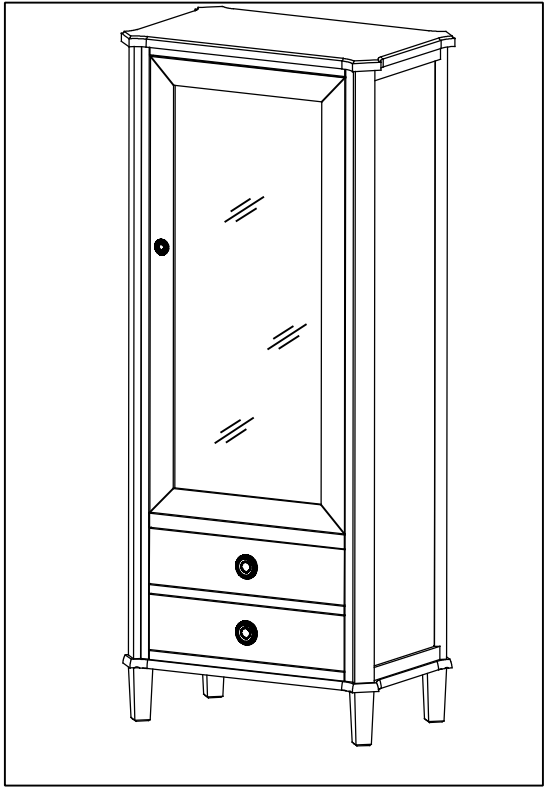
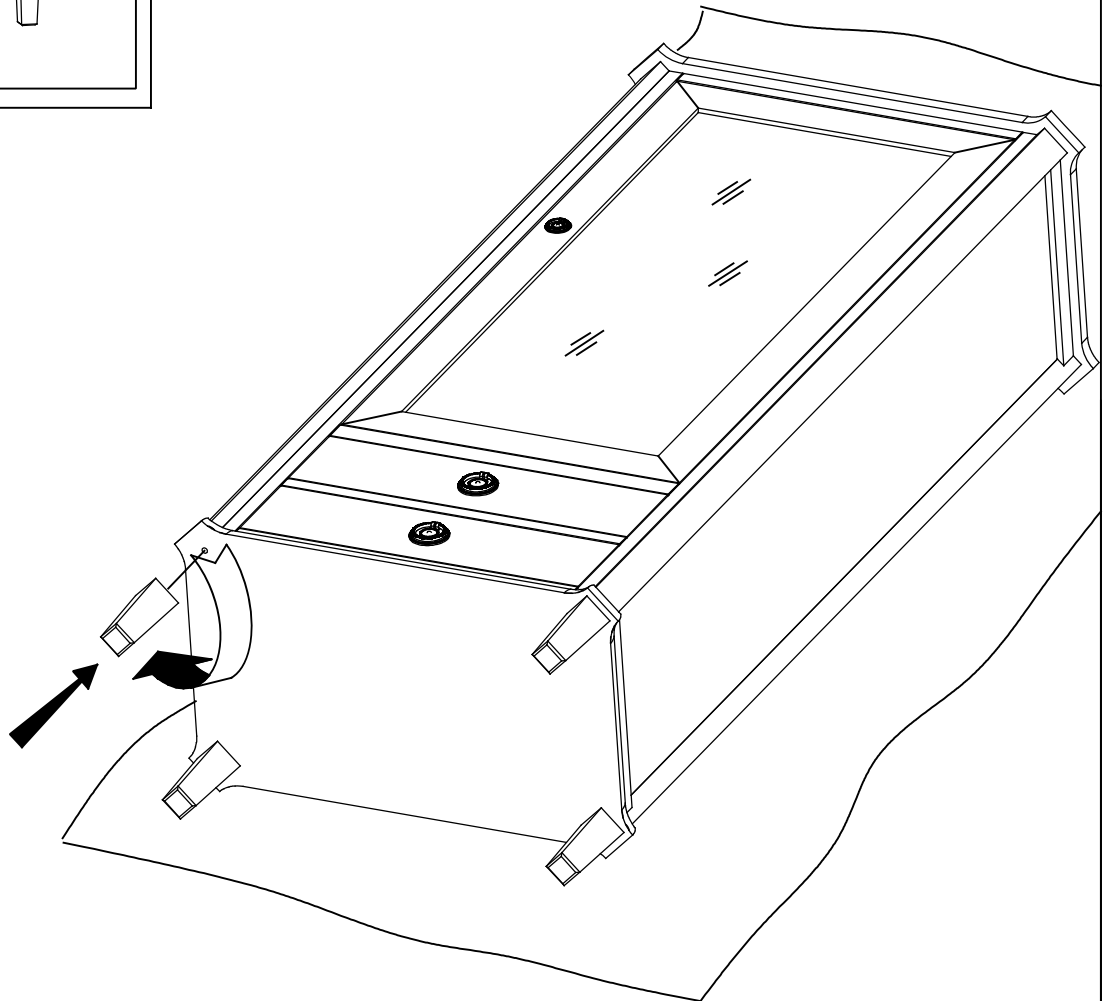
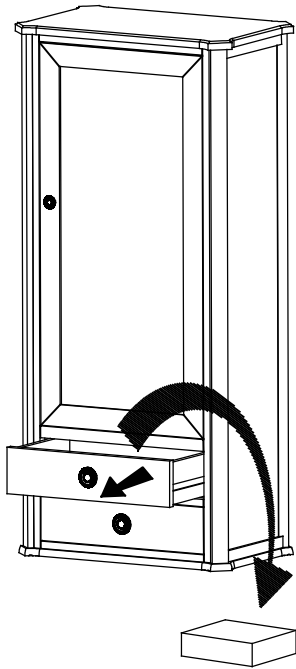

2.

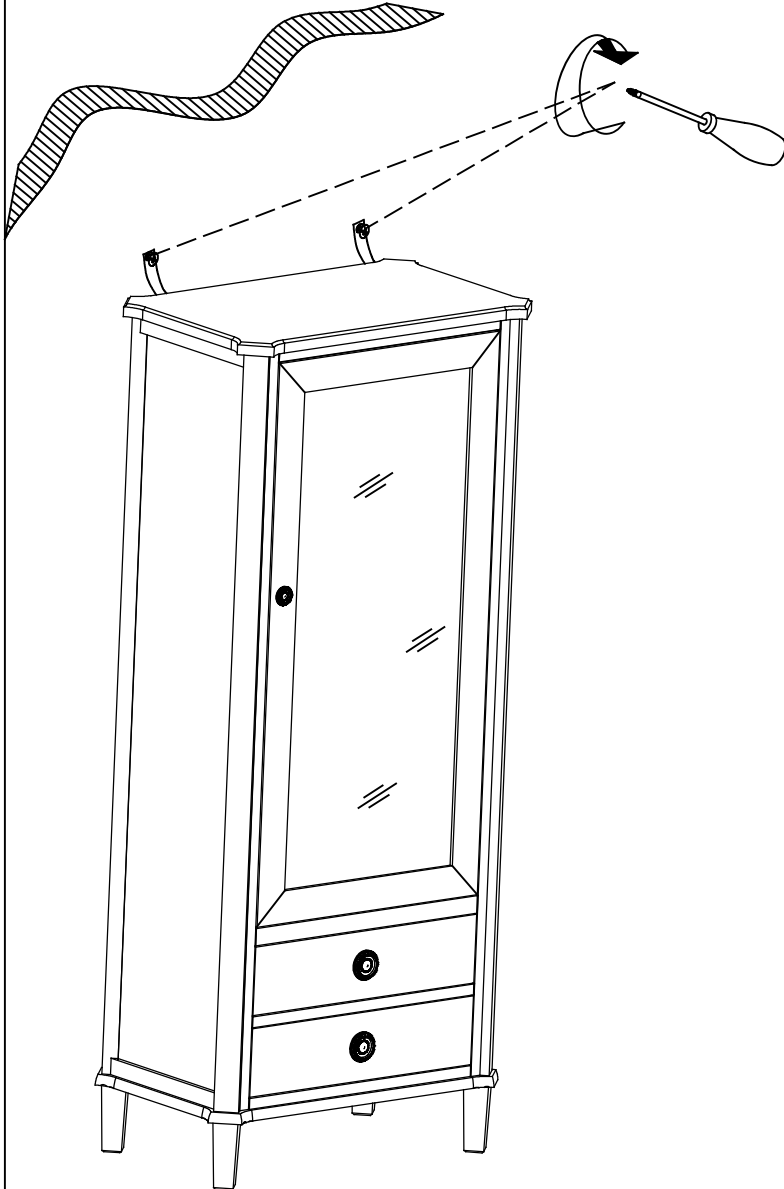
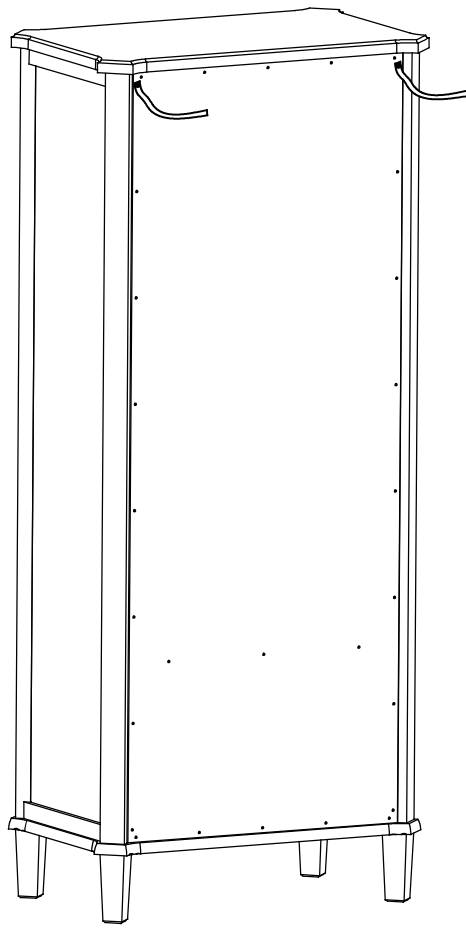

Important note: It is essential that this product is fixed to a wall using the strap supplied.

Wall fixing is not supplied, please purchase suitable fixing for the wall

Always ensure that the wall Attachment strap is correctly fitted.

3.

